

R-2000iD/210FH



Max. load capacity
at wrist: **210 kg**



Max. reach:
2605 mm

Controlled axes	Repeatability (mm)	Mechanical weight (kg)	Motion range (°)						Maximum speed (°/s)						J4 Moment/ Inertia (Nm/kgm ²)	J5 Moment/ Inertia (Nm/kgm ²)	J6 Moment/ Inertia (Nm/kgm ²)
			J1	J2	J3	J4	J5	J6	J1	J2	J3	J4	J5	J6			
6	± 0.05*	1130	370	140	234	420	250	420	120	90	100	140	130	220	1380/228	1380/228	735/196

Working range

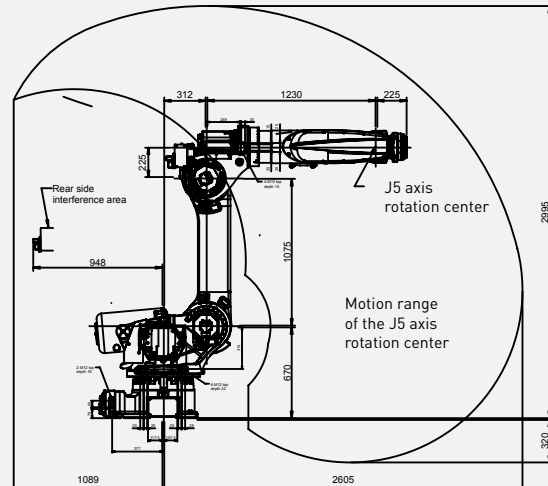
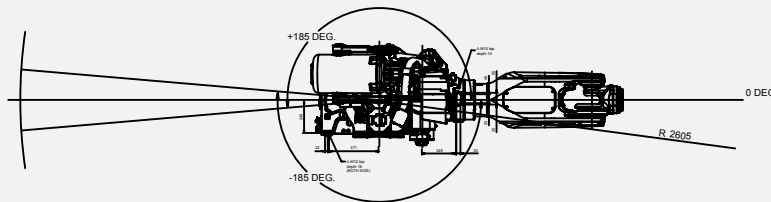

Robot

R-2000iD/210FH

Robot footprint [mm]	678 x 536
Mounting position Floor	●
Mounting position Upside down	-
Mounting position Angle	-



Controller

R-30iB Plus

Open air cabinet	-
Mate cabinet	○
A-cabinet	●
B-cabinet	○
iPendant Touch	●

Electrical connections

Voltage 50/60Hz 3phase [V]	380-575
Voltage 50/60Hz 1phase [V]	-
Average power consumption [kW]	2.5

Integrated services

Integrated signals on upper arm In/Out	8/8
Integrated air supply	2

Environment

Acoustic noise level [dB]	-
Ambient temperature [° C]	0-45

Protection

Body standard/optional	IP54
Wrist & J3 arm standard/optional	IP67

● standard ○ on request - not available () with hardware and/or software option

*Based on IS09283