

SR-6iA



Max. load capacity
at wrist: **6kg**



Max. reach:
650 mm

Controlled axes	Repeatability (mm)	Mechanical weight (kg)	Motion range (°)						Maximum speed (°/s)						J4 Inertia (kgm ²)	J5 Inertia (kgm ²)	J6 Inertia (kgm ²)
			J1	J2	J3	J4	J5	J6	J1	J2	J3	J4	J5	J6			
4	± 0.01 (J1,J2, J3) ± 0.004 (J4)	30	296	300	210mm	1440	-	-	440	700	2000 mm/sec	2500	-	-	0.12	-	-

Working range

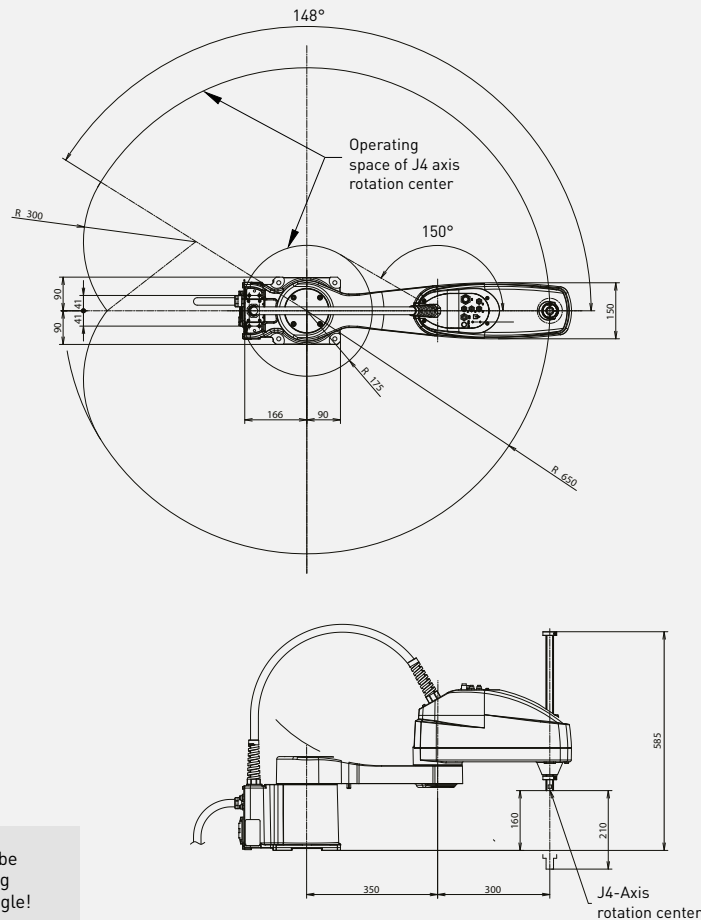

Motion range may be restricted according to the mounting angle!

Robot

	SR-6iA
Robot footprint [mm]	180 x 256 (397)
Mounting position Floor	●
Mounting position Ceiling	-
Mounting position Angle	-
Mounting position Wall	○

Controller

	R-30iB Plus
Compact Plus	●
Open air cabinet	-
Mate cabinet	-
A-cabinet	-
B-cabinet	-
iPendant Touch	-

Electrical connections

Voltage 50/60Hz 3phase [V]	-
Voltage 50/60Hz 1phase [V]	200-230
Average power consumption [kW]	0.35

Integrated services

Integrated signals on upper arm In/Out	4/4
Integrated air supply	2
Integrated solenoid valve	2

Environment

Acoustic noise level [dB]	<70
Ambient temperature [° C]	0-45

Protection

Body standard/optional	IP20
Wrist & J3 arm standard/optional	IP20

Auxiliary

Max. push-down force (Newton)	200
-------------------------------	-----