

M-410iC/315 (Hollow wrist)



Max. load capacity
at wrist: **315 kg**



Max. reach:
3143 mm

Controlled axes	Repeatability (mm)	Mechanical weight (kg)	Motion range (°)						Maximum speed (°/s)						J4 Moment/ Inertia (Nm/kgm ²)	J5 Moment/ Inertia (Nm/kgm ²)	J6 Moment/ Inertia (Nm/kgm ²)
			J1	J2	J3	J4	J5	J6	J1	J2	J3	J4	J5	J6			
4	± 0.05	1600 (1300)	360	144	136	720	-	-	90	100	110	195	-	-	155	-	-

Working range

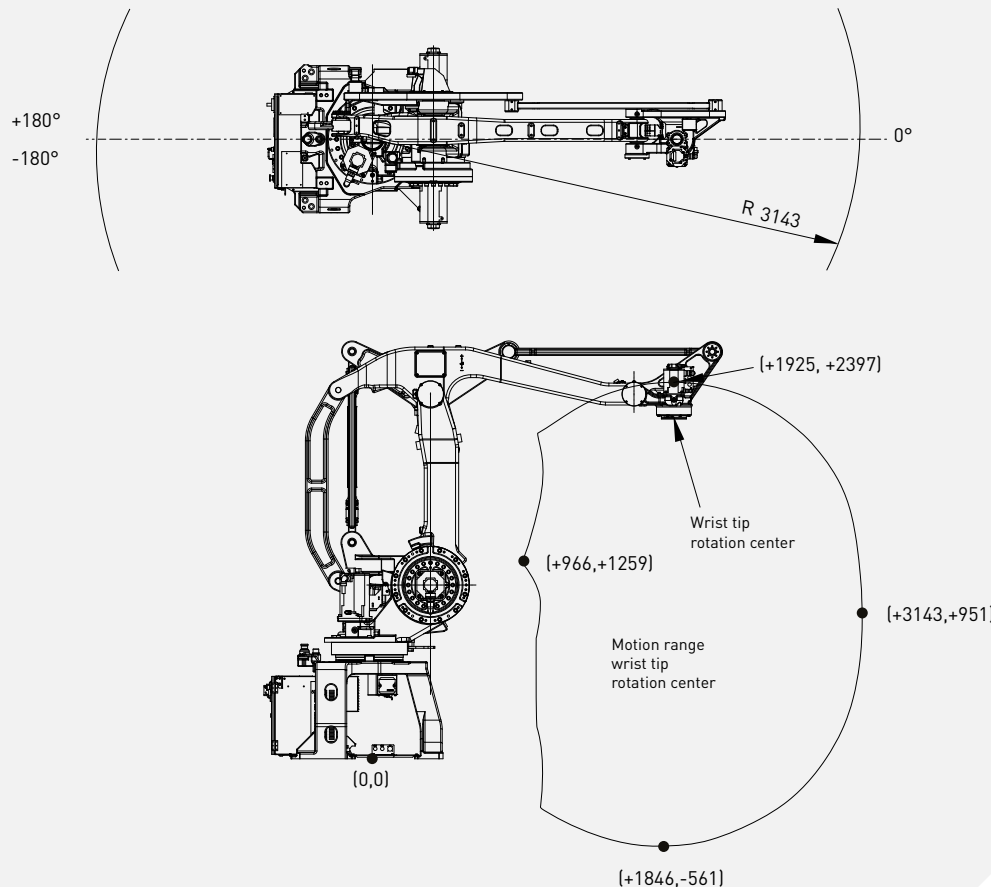

Robot

Robot		M-410iC/315
Robot footprint [mm]		1094 x 945 (806 x 610)
Mounting position Floor		●
Mounting position Upside down		-
Mounting position Angle		-

Controller

Controller		R-30iB Plus
Open air cabinet		-
Mate cabinet		-
A-cabinet		●
B-cabinet		○
iPendant Touch		●

Electrical connections

Voltage 50/60Hz 3phase [V]	380-575
Voltage 50/60Hz 1phase [V]	-
Average power consumption [kW]	1

Integrated services

Integrated signals on upper arm In/Out	8/8
Integrated air supply	1

Environment

Acoustic noise level [dB]	75.3
Ambient temperature [° C]	0-45

Protection

Body standard/optional	IP54
Wrist & J3 arm standard/optional	IP54

● standard ○ on request - not available () with hardware and/or software option